

Schematic Symbol for XC3S500ECP132

The Schematic symbol consists of 6 heterogeneous parts that are listed below:

1. IO bank 0

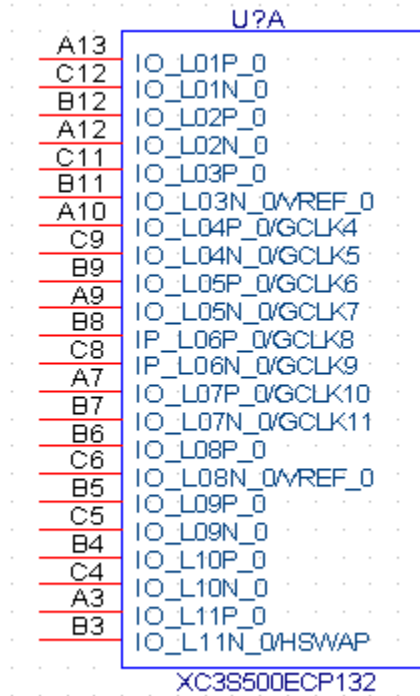

2. IO bank 1

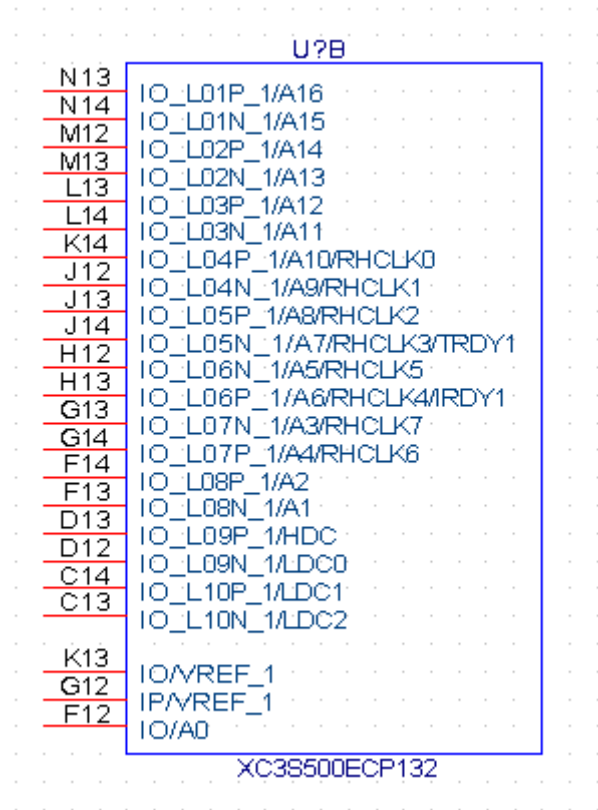

3. IO bank 2

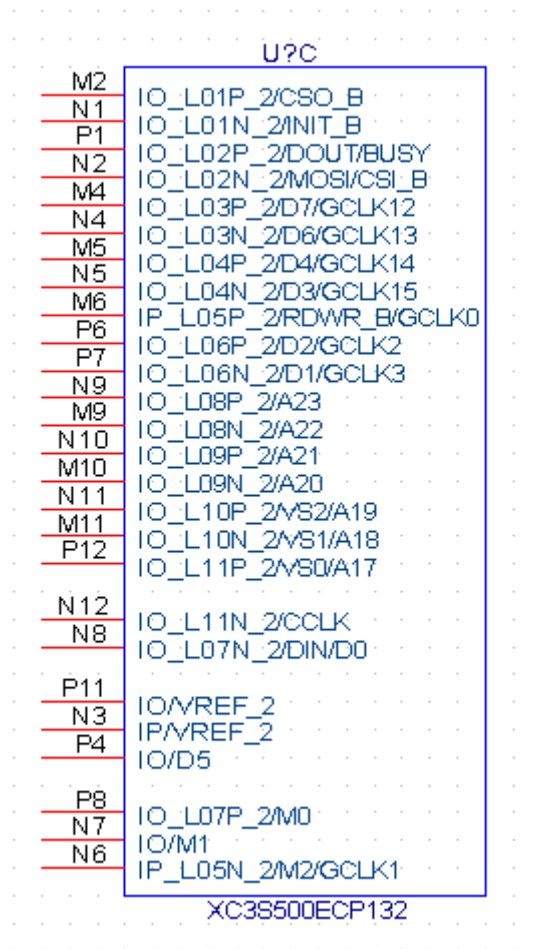

4. IO bank 3

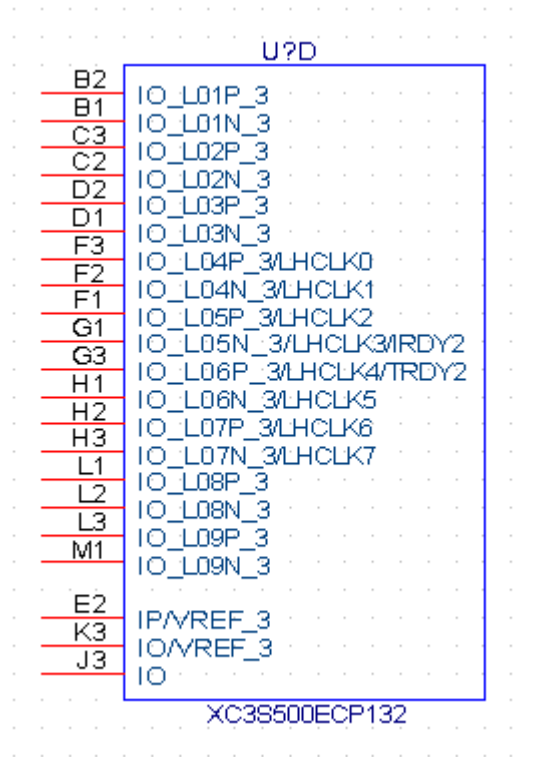

5. Ground Power

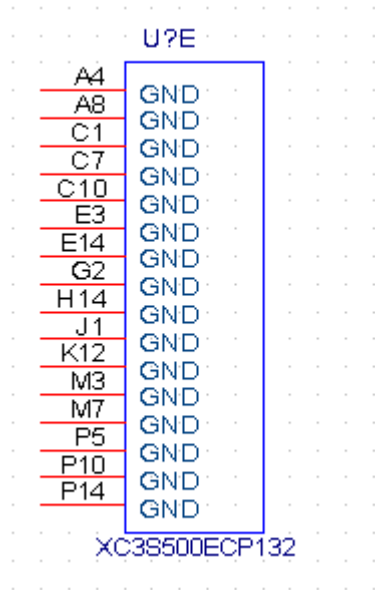

6. Power

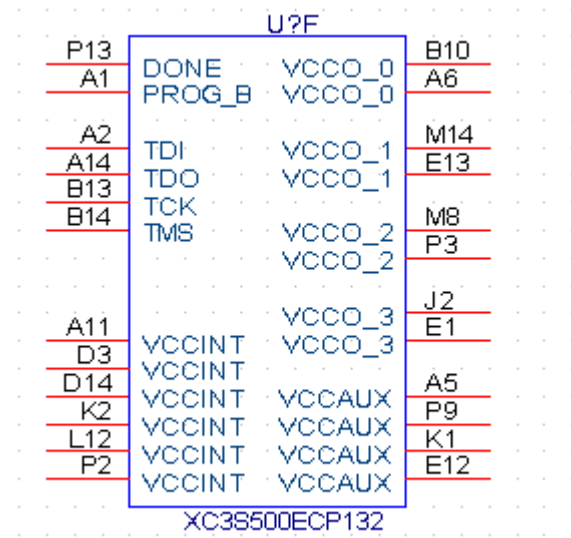

7. Revision History

	Revision	Date	By	Comments
1	1.01	March 15, 2007	MD	Initial Release